

X-Eng is a division of
Foundry 4x4 Limited
The Old Bakery,
Rear of Vale Terrace,
Tredegar, Gwent. NP22 4HT

38mm

X-Fan Fitting Instructions

Thank you for choosing to buy an X-Fan - Electric Fan Adaptor.

The adaptor should be fitted in the bottom radiator hose. The water flows in to the top of the radiator and out of the bottom so the sensor will detect when the radiator is not providing enough cooling itself and switch on one or both fans to provide more.

The contacts within the thermostatic switch are rated up to 17A. Although many fans have a continuous rating below 17A, most require a start-up current of many times this. We therefore recommend you use a relay between the thermostat and the fan(s).

Any wire used must be capable of handling at least 30A (as it may be carrying the current to run both fans)

We have provided circuits for a number of different configurations of fans and switches. With a bit of luck, one will suit your application.

What's inside the Thermostatic Switch?

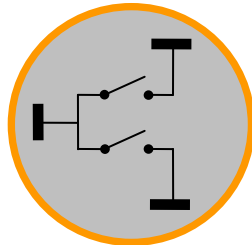

The 50091 switch just contains a pair of switches controlled by bi-metallic strips (which bend proportionally to the temperature). When the temp is high enough, the strip closes the contacts, completing that circuit.

In the following diagrams, the symbol below represents a standard automotive relay. The purpose of a relay is to increase the current that a circuit can safely switch, in this case, your fan(s). Pay attention to the orientation of the connections on the relay. Some relays have numbers beside the pins and some have an extra pin in the middle – just ignore these.



Two Fans, Low and High Temperature

The diagram below shows the simplest way to wire up a pair of fans using a 2 pole, centre off toggle switch for control.

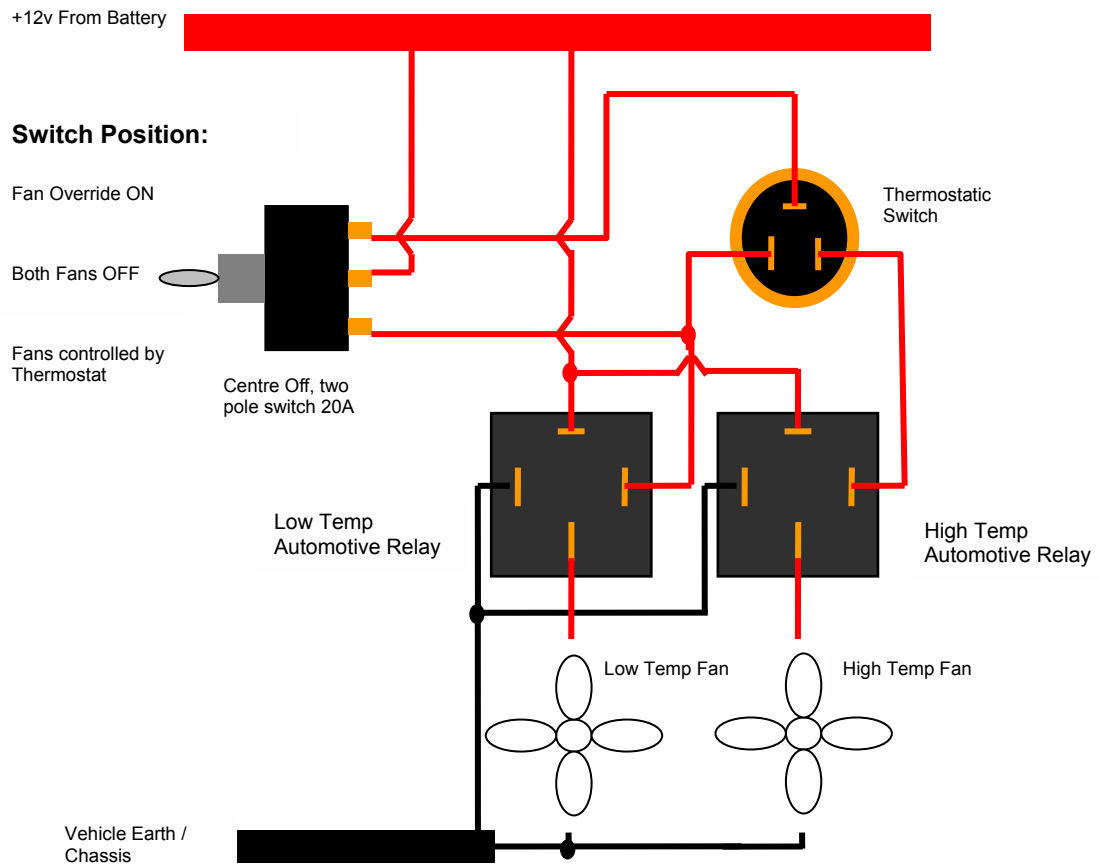

One Fan, Low and High Temperature selectable from the cab

The circuit below shows how to use our dual switch to control a single fan, but with two temperature ranges. Use the lower range while off road or towing and the high range perhaps on the motorway (more ram air cooling) or in particularly cold weather.

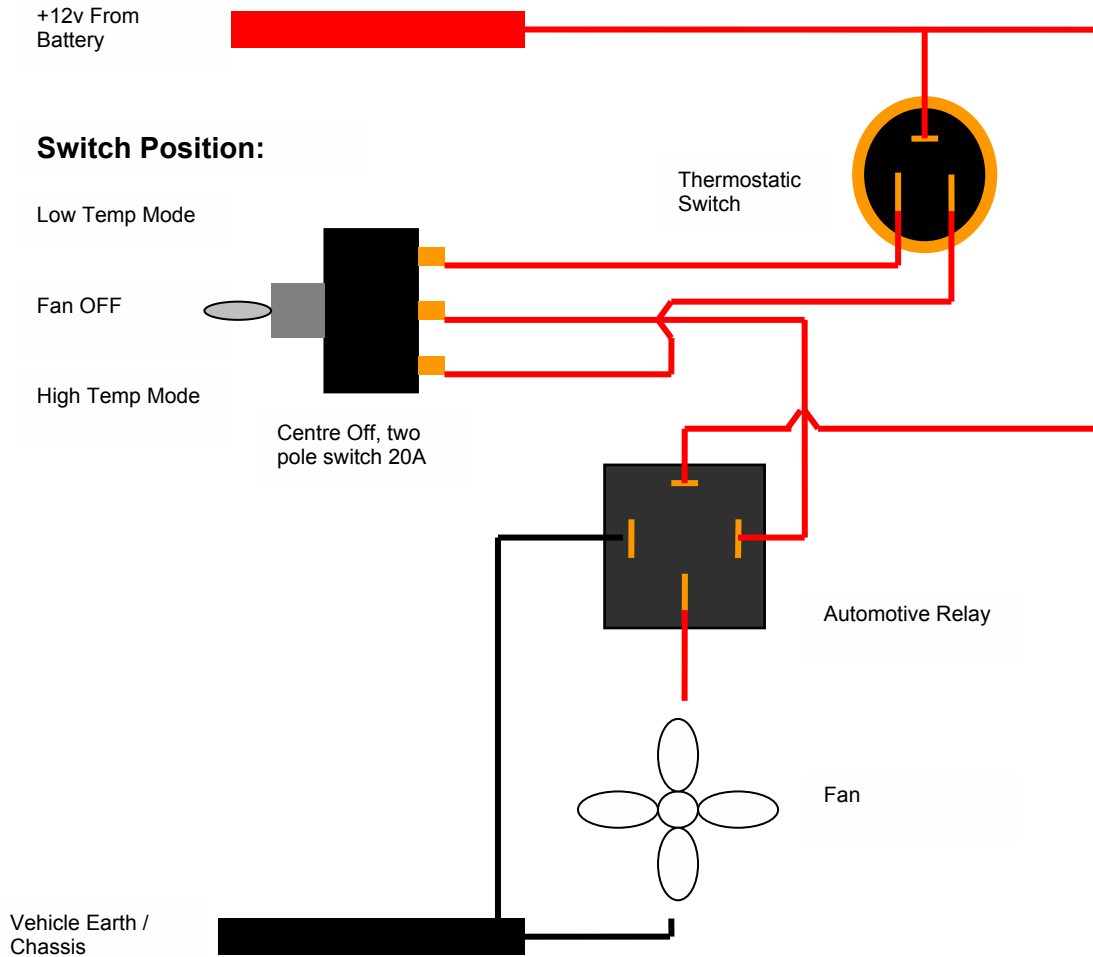

Carling Switch Wiring Instructions

Each of the preceding diagrams shows a representation of a toggle switch. The wiring of a carling switch is slightly different. Rather than repeat all the previous diagrams, this shows how to substitute the Carling switch for the toggle switch.

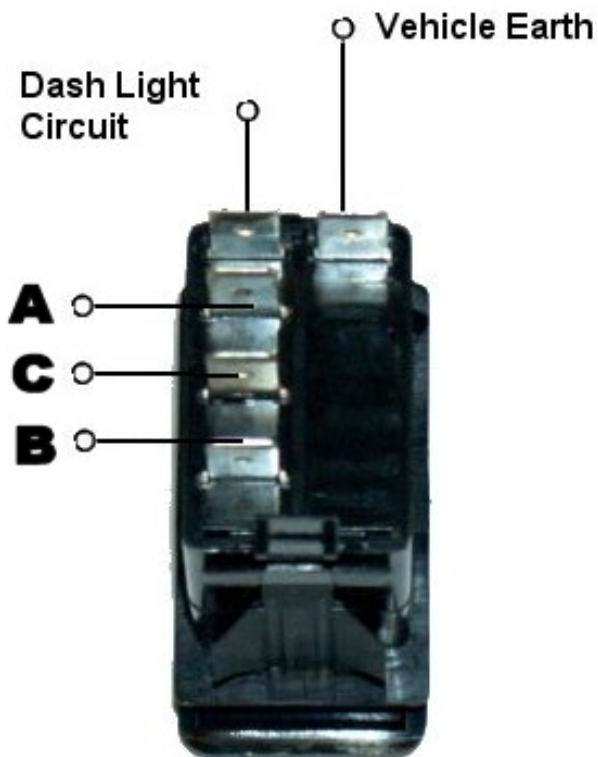
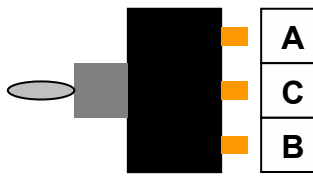

The letters A,C & B are shown for the corresponding terminals on each type of switch. If you would like the switch to light up with your other dash panel lights, then connect the top two terminals as shown.